

Hybrid Coupled Mode Modelling in 3-D: Perturbed and Coupled Channels, and Waveguide Crossings



Manfred Hammer*, Samer Alhaddad, Jens Förstner



Theoretical Electrical Engineering
Paderborn University, Germany

MATHEON Workshop, 11th Annual Meeting "Photonic Devices", Zuse Institute Berlin, Germany — February 8-9, 2018

*Theoretical Electrical Engineering, Paderborn University
Warburger Straße 100, 33098 Paderborn, Germany

Phone: +49(0)5251/60-3560
E-mail: manfred.hammer@uni-paderborn.de

Wave interaction in photonic integrated circuits

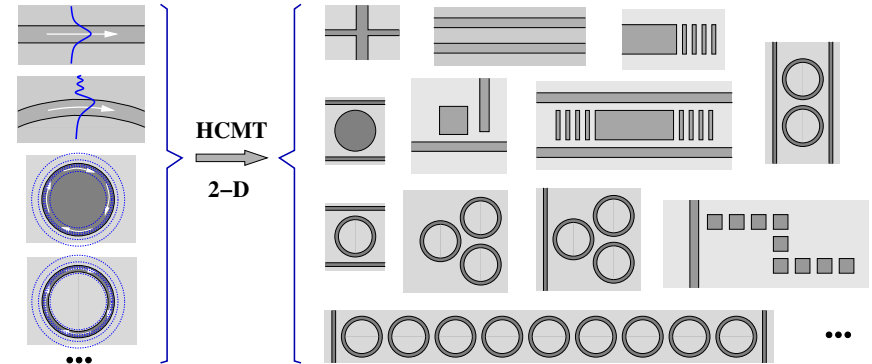

Wave interaction in photonic integrated circuits

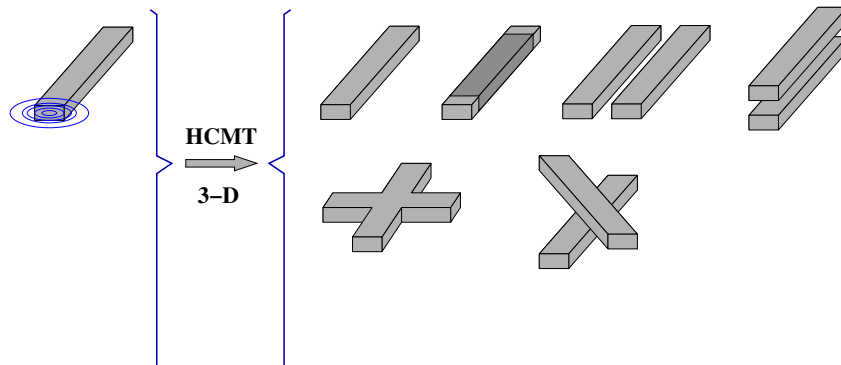

Hybrid Coupled Mode Modelling in 3-D

- Hybrid coupled mode theory (HCMT)
 - Field template
 - Amplitude discretization
 - Solution procedure
- Basis fields, 3-D
- Single straight channels
- Parallel waveguides
- Waveguide crossings

Frequency domain,
 $\sim \exp(i\omega t),$

$$\left. \begin{aligned} \nabla \times \mathbf{H} - i\omega\epsilon_0\epsilon\mathbf{E} &= 0, \\ -\nabla \times \mathbf{E} - i\omega\mu_0\mathbf{H} &= 0, \end{aligned} \right\}$$

$\omega = kc = 2\pi c/\lambda$ given,
 $\epsilon = n^2, \quad n(x, y, z).$

A waveguide crossing

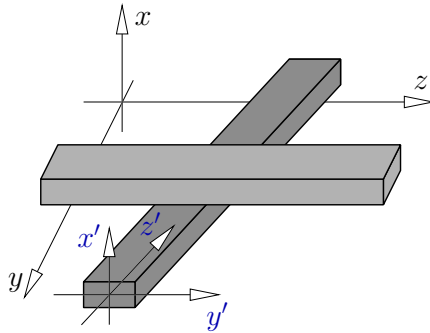

... local coordinates x', y', z' , per channel, per mode.

Field template, local

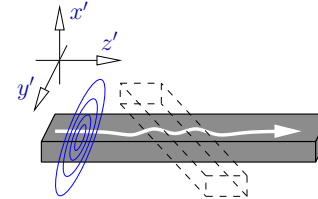

Guided mode with profile $(\tilde{\mathbf{E}}, \tilde{\mathbf{H}})$,
propagation constant $\beta = k n_{\text{eff}}$:

$$\begin{pmatrix} \mathbf{E} \\ \mathbf{H} \end{pmatrix}(x', y', z') \approx a(z') \begin{pmatrix} \tilde{\mathbf{E}} \\ \tilde{\mathbf{H}} \end{pmatrix}(x', y') e^{-i\beta z'}, \quad a = ?$$

Field template, local

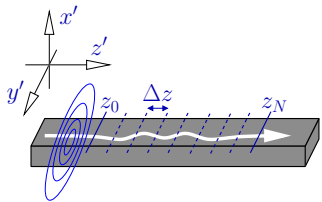

Guided mode with profile $(\tilde{\mathbf{E}}, \tilde{\mathbf{H}})$,
propagation constant $\beta = k n_{\text{eff}}$:

$$\begin{pmatrix} \mathbf{E} \\ \mathbf{H} \end{pmatrix}(x', y', z') \approx a(z') \begin{pmatrix} \tilde{\mathbf{E}} \\ \tilde{\mathbf{H}} \end{pmatrix}(x', y') e^{-i\beta z'}, \quad a = ?$$

$$a(z') = \sum_{j=0}^N a_j \alpha_j(z'),$$

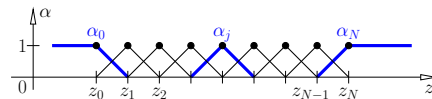

$$\begin{pmatrix} \mathbf{E} \\ \mathbf{H} \end{pmatrix}(x', y', z') = \sum_j a_j \left(\alpha_j(z') \begin{pmatrix} \tilde{\mathbf{E}} \\ \tilde{\mathbf{H}} \end{pmatrix}(x', y') e^{-i\beta z'} \right) =: \sum_j a_j \begin{pmatrix} \mathbf{E}_j \\ \mathbf{H}_j \end{pmatrix}(x', y', z'), \quad a_j = ?$$

Field template, global

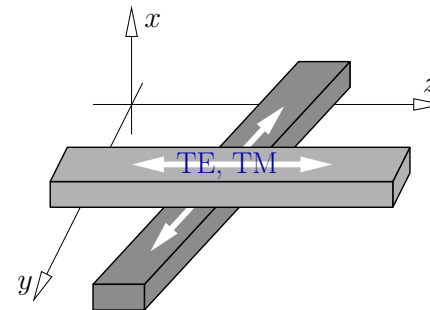

- Local ansatz for all channels, modes,
- $(x', y', z') \rightsquigarrow (x, y, z)$,
- \sum (local contributions)

$$\begin{pmatrix} \mathbf{E} \\ \mathbf{H} \end{pmatrix}(x, y, z) = \sum_k a_k \begin{pmatrix} \mathbf{E}_k \\ \mathbf{H}_k \end{pmatrix}(x, y, z), \quad a_k = ?$$

Galerkin procedure

$$\begin{cases} \nabla \times \mathbf{H} - i\omega\epsilon_0\epsilon\mathbf{E} = 0 \\ -\nabla \times \mathbf{E} - i\omega\mu_0\mathbf{H} = 0 \end{cases} \quad \cdot \begin{pmatrix} \mathbf{F} \\ \mathbf{G} \end{pmatrix}^*, \quad \iiint$$

$$\iff \iiint \mathcal{K}(\mathbf{F}, \mathbf{G}; \mathbf{E}, \mathbf{H}) \, dx \, dy \, dz = 0 \quad \text{for all } \mathbf{F}, \mathbf{G},$$

where

$$\mathcal{K}(\mathbf{F}, \mathbf{G}; \mathbf{E}, \mathbf{H}) = \mathbf{F}^* \cdot (\nabla \times \mathbf{H}) - \mathbf{G}^* \cdot (\nabla \times \mathbf{E}) - i\omega\epsilon_0\epsilon\mathbf{F}^* \cdot \mathbf{E} - i\omega\mu_0\mathbf{G}^* \cdot \mathbf{H}.$$

Further issues

... plenty.

Galerkin procedure, continued

- Insert $\begin{pmatrix} \mathbf{E} \\ \mathbf{H} \end{pmatrix} = \sum_k a_k \begin{pmatrix} \mathbf{E}_k \\ \mathbf{H}_k \end{pmatrix},$
- select $\{\mathbf{u}\}$: indices of unknown coefficients,
 $\{\mathbf{g}\}$: given values related to prescribed influx,
- require $\iiint \mathcal{K}(\mathbf{E}_l, \mathbf{H}_l; \mathbf{E}, \mathbf{H}) \, dx \, dy \, dz = 0$ for $l \in \{\mathbf{u}\},$
- compute $K_{lk} = \iiint \mathcal{K}(\mathbf{E}_l, \mathbf{H}_l; \mathbf{E}_k, \mathbf{H}_k) \, dx \, dy \, dz.$

$$\sum_{k \in \{\mathbf{u}, \mathbf{g}\}} K_{lk} a_k = 0, \quad l \in \{\mathbf{u}\}, \quad (\mathbf{K}_{\mathbf{u}\mathbf{u}} \quad \mathbf{K}_{\mathbf{u}\mathbf{g}}) \begin{pmatrix} \mathbf{a}_{\mathbf{u}} \\ \mathbf{a}_{\mathbf{g}} \end{pmatrix} = 0, \quad \text{or} \quad \mathbf{K}_{\mathbf{u}\mathbf{u}} \mathbf{a}_{\mathbf{u}} = -\mathbf{K}_{\mathbf{u}\mathbf{g}} \mathbf{a}_{\mathbf{g}}.$$

Basis modes

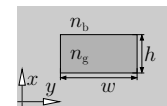

$\lambda = 1.55 \, \mu\text{m},$
 $n_b = 1.45,$
 $n_g = 1.99,$
 $w = 1.0 \, \mu\text{m},$
 $h = 0.4 \, \mu\text{m};$

$x \in [-2, 2] \, \mu\text{m},$
 $y \in [-2, 2] \, \mu\text{m};$

TE-like

$n_{\text{eff,TE}} = 1.63554$

[JCMwave].

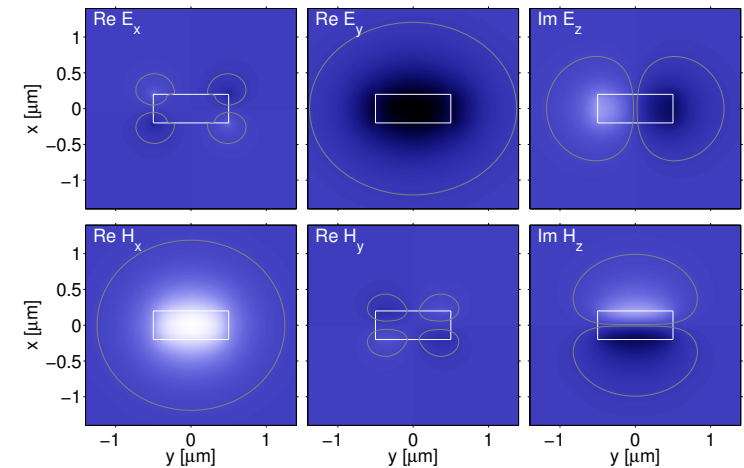

Basis modes

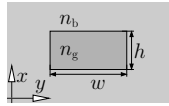

$\lambda = 1.55 \mu\text{m}$,
 $n_b = 1.45$,
 $n_g = 1.99$,
 $w = 1.0 \mu\text{m}$,
 $h = 0.4 \mu\text{m}$;

$x \in [-2, 2] \mu\text{m}$,
 $y \in [-2, 2] \mu\text{m}$;

TM-like

$n_{\text{eff, TM}} = 1.56809$

[JCMwave].

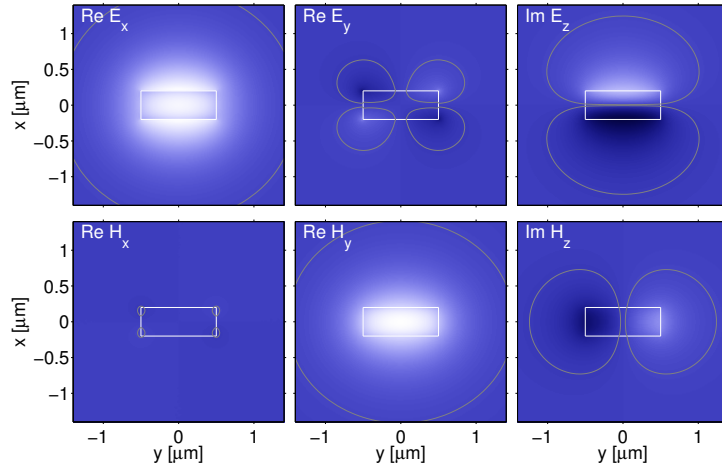

A single channel

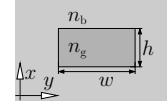

$z \in [0, 10] \mu\text{m}$,
 $\Delta z = 0.5 \mu\text{m}$.

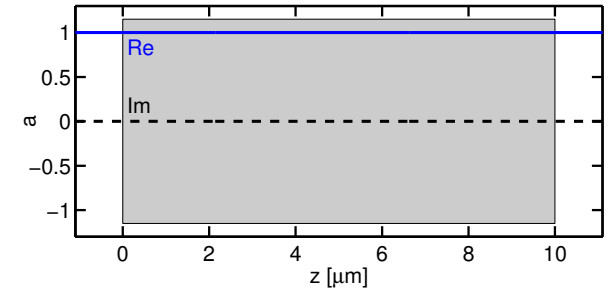
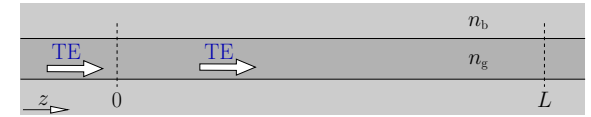

A single channel

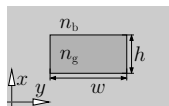

$z \in [-5, 5] \mu\text{m}$,
 $\Delta z = 0.5 \mu\text{m}$.

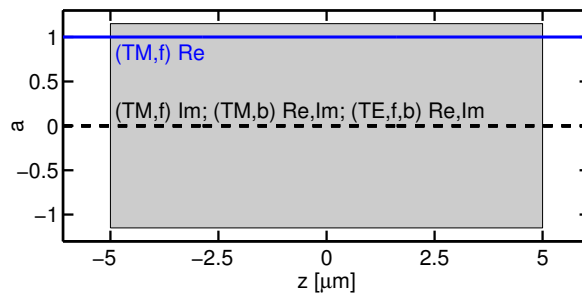
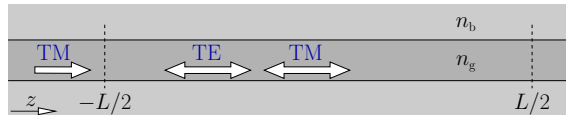

A single channel

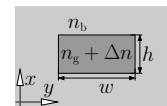

$z \in [0, 10] \mu\text{m}$,
 $\Delta z = 0.5 \mu\text{m}$.

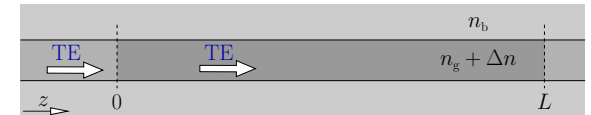

$$e^{-ikn_{\text{eff}}^p z} = a(z) e^{-ikn_{\text{eff}}^0 z},$$

$$a(z) \rightsquigarrow \Delta n_{\text{eff}} = n_{\text{eff}}^p - n_{\text{eff}}^0.$$

TE, $\Delta n = 0.1$	Δn_{eff}
HCMT	0.075
JCMwave	0.078

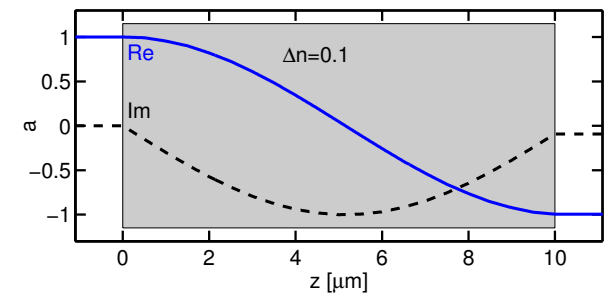

A single channel

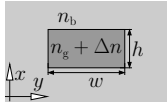

$z \in [0, 10] \mu\text{m}$,
 $\Delta z = 0.5 \mu\text{m}$.

$$e^{-ikn_{\text{eff}}^p z} = a(z) e^{-ikn_{\text{eff}}^0 z},$$

$$a(z) \rightsquigarrow \Delta n_{\text{eff}} = n_{\text{eff}}^p - n_{\text{eff}}^0.$$

TE, $\Delta n = 0.2$	Δn_{eff}
HCMT	0.154
JCMwave	0.162

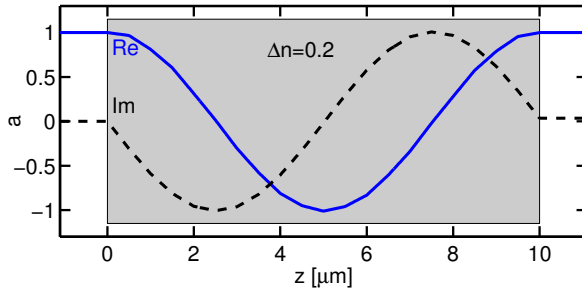
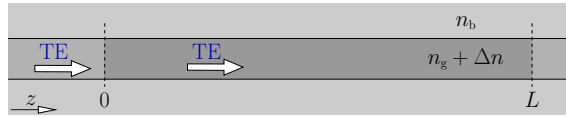

Parallel channels, horizontal coupling

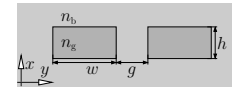

TE, $\lambda = 1.55 \mu\text{m}$, $n_b = 1.45$, $n_g = 1.99$,
 $w = 1.0 \mu\text{m}$, $h = 0.4 \mu\text{m}$, $g = 0.2 \mu\text{m}$.

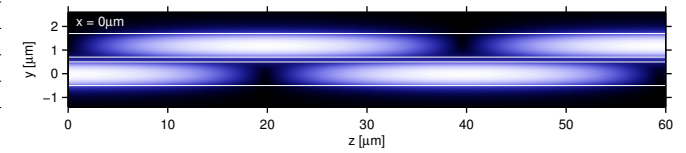
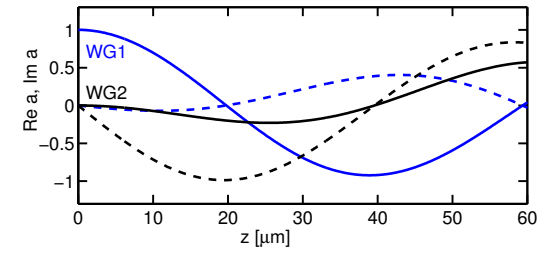
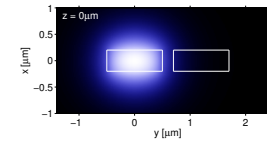

Parallel channels, horizontal coupling

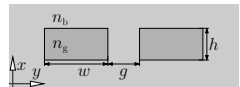

TE, $\lambda = 1.55 \mu\text{m}$, $n_b = 1.45$, $n_g = 1.99$,
 $w = 1.0 \mu\text{m}$, $h = 0.4 \mu\text{m}$, $g = 0.2 \mu\text{m}$.

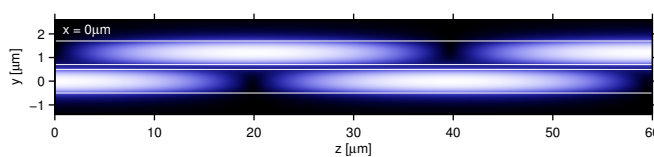
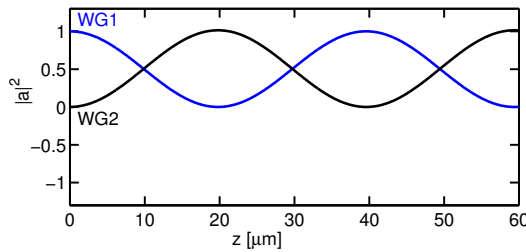
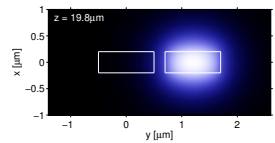
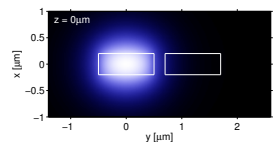

Parallel channels, vertical coupling

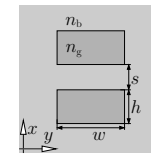

TE,
 $\lambda = 1.55 \mu\text{m}$,
 $n_b = 1.45$,
 $n_g = 1.99$,
 $w = 1.0 \mu\text{m}$,
 $h = 0.4 \mu\text{m}$,
 $s = 0.2 \mu\text{m}$.

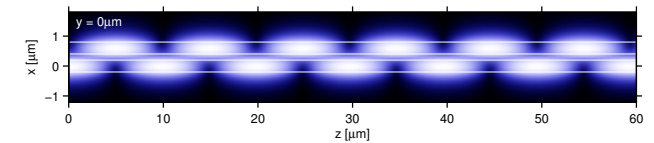
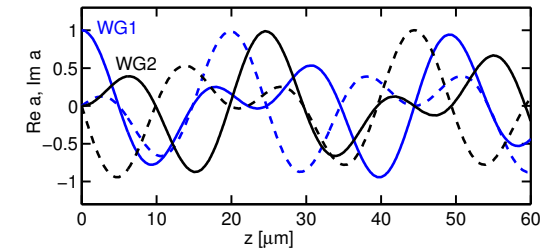
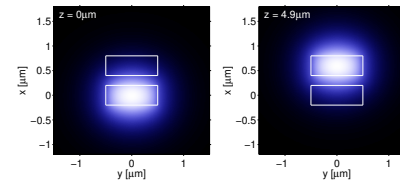

Parallel channels, vertical coupling

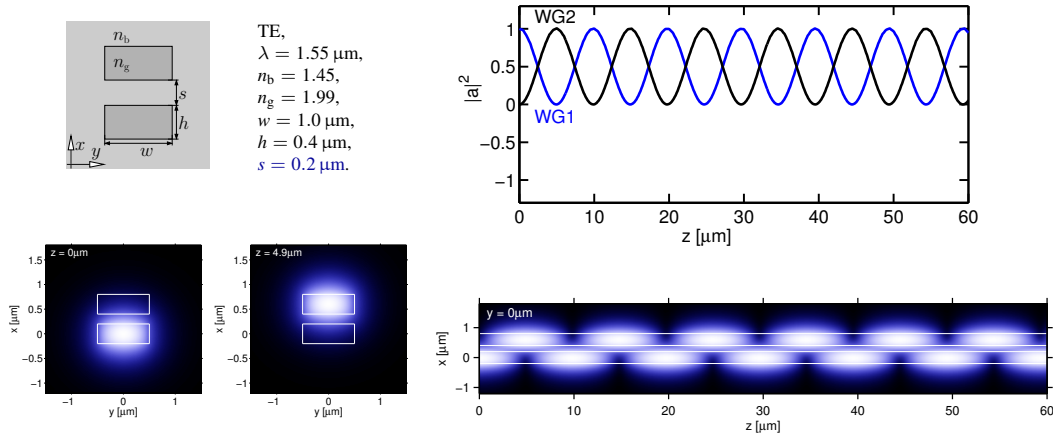

Parallel channels, coupling length

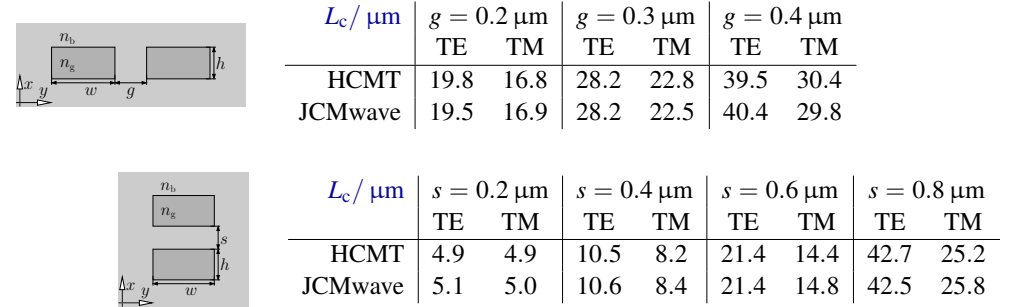

HCMT: $a(z) \rightsquigarrow L_c$,
 JCMwave: $L_c = \pi / |\beta_s - \beta_a|$.

Waveguide crossing, perpendicular

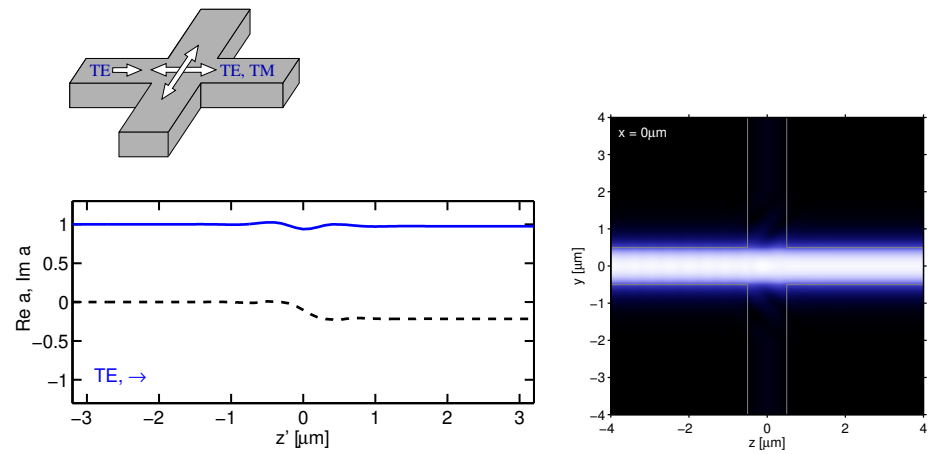

Waveguide crossing, perpendicular

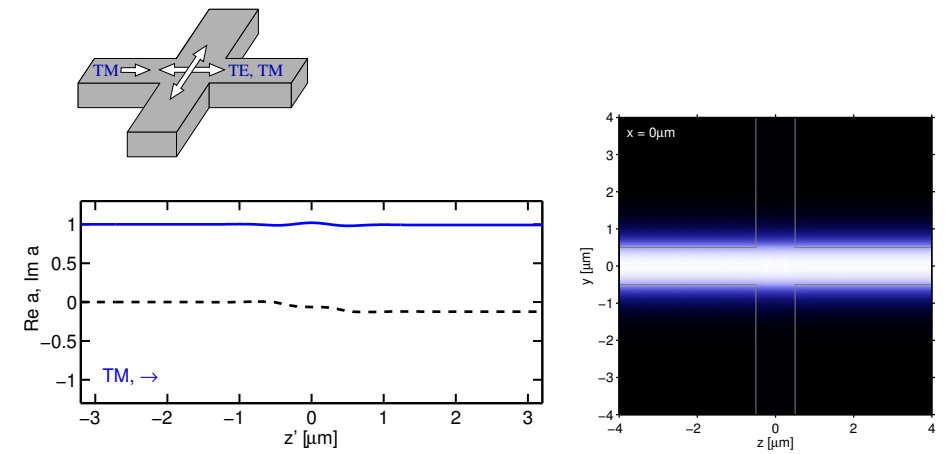

Waveguide crossing, perpendicular, reference

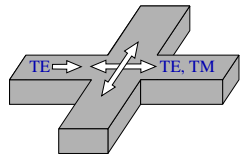

	TE, \rightarrow	TE, \leftarrow	TE, \uparrow, \downarrow	TM, $\rightarrow, \leftarrow, \uparrow, \downarrow$
[*]	87%	< 0.1%	< 0.1%	< 10^{-6}

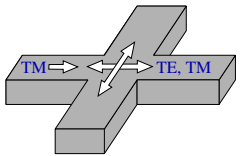

	TM, \rightarrow	TM, \leftarrow	TM, \uparrow, \downarrow	TE, $\rightarrow, \leftarrow, \uparrow, \downarrow$
[*]	92%	< 0.1%	< 0.1%	< 10^{-6}

[*] CST Microwave Studio

Waveguide crossing, oblique

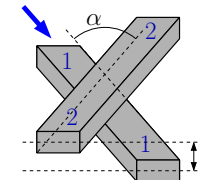

$\alpha = 9.44^\circ$,
TE input,
 $s = 0.6 \mu\text{m}$.

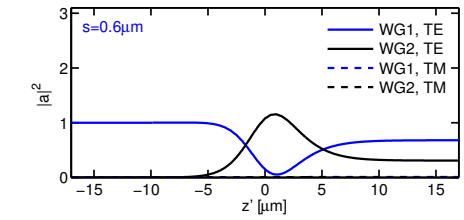
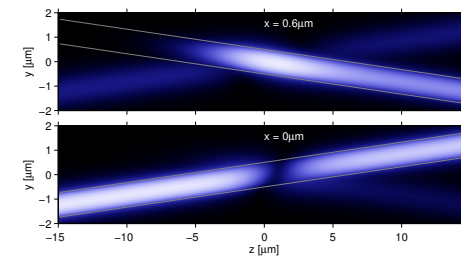
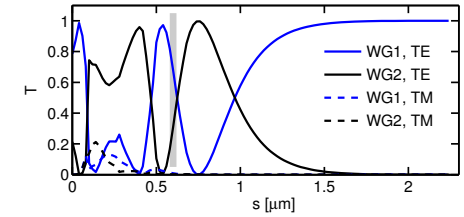

Waveguide crossing, oblique

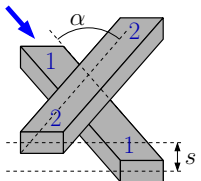

$\alpha = 9.44^\circ$,
TE input,
 $s = 0.0 \mu\text{m}$.

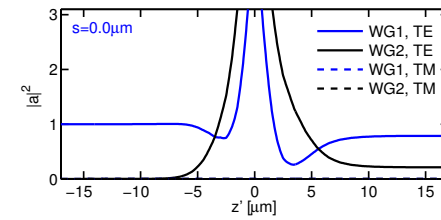
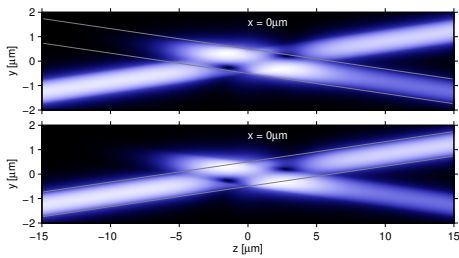
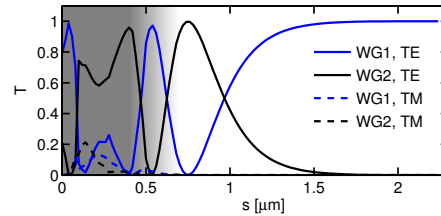

Waveguide crossing, oblique

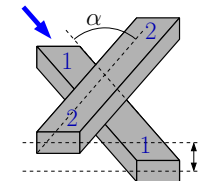

$\alpha = 9.44^\circ$,
TM input,
 $s = 0.3 \mu\text{m}$.

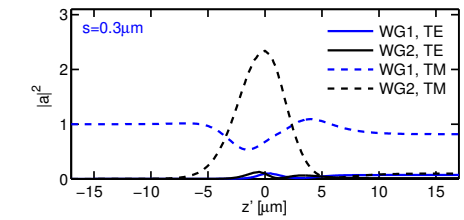
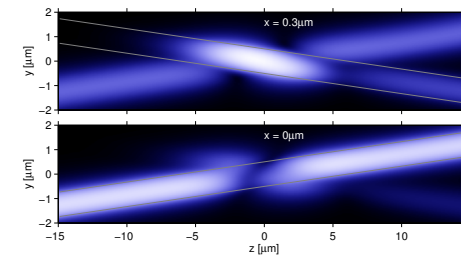
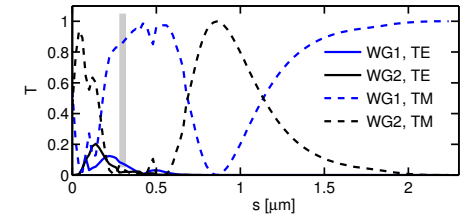

Waveguide crossing, oblique

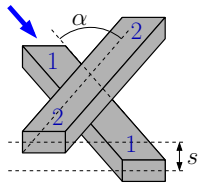

$\alpha = 9.44^\circ$,
TM input,
 $s = 0.0 \mu\text{m}$.

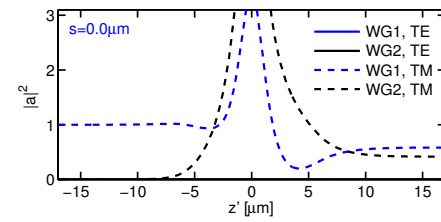
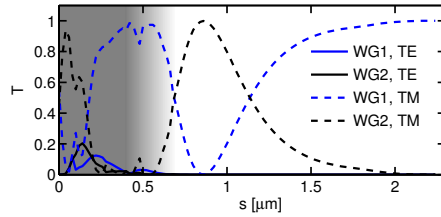
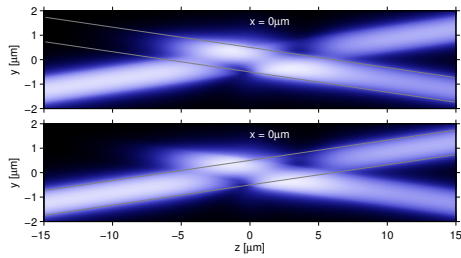

Waveguide crossing, oblique

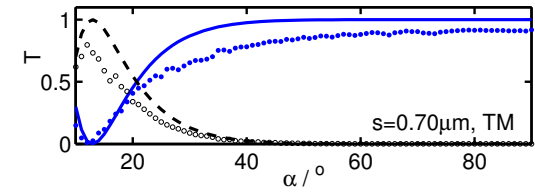
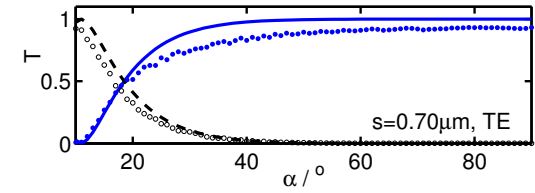
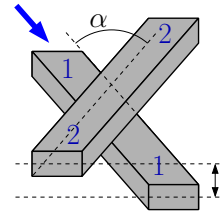

●●●○○○ CST Microwave Studio

Waveguide crossing, oblique

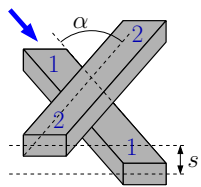

TE,
 $s = 0.7 \mu\text{m}$,
 $\alpha = 18.5^\circ$.

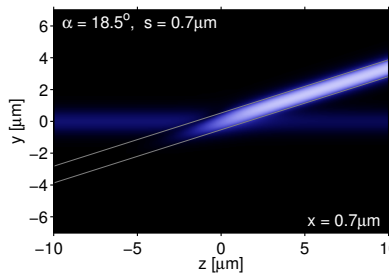
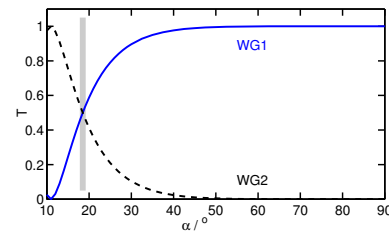
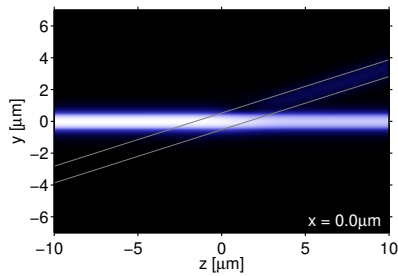

Computational effort

α	HCMT			CST MWS (Frequency domain solver)		
	memory	runtime	comp. interval	memory	runtime	comp. volume
70°	150 MB	6 min	$[-1.3, 1.3] \mu\text{m}$	9.4 GB	1 h, 10 min	$728 \mu\text{m}^3$
18.5°	150 MB	18 min	$[-7.5, 7.5] \mu\text{m}$	41 GB	12 h, 48 min	$1928 \mu\text{m}^3$
11°	150 MB	28 min	$[-13, 13] \mu\text{m}$	92 GB	50 h, 22 min	$3157 \mu\text{m}^3$

* Linux, g++, a single core

* MS Windows Server, up to 8 cores

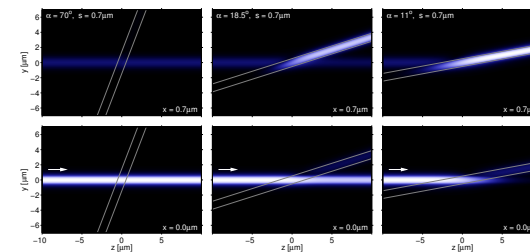

* Intel Xeon CPUs (2.9 GHz),
128 GB memory.

Concluding remarks

Hybrid Coupled Mode Theory:

- an ab-initio, quantitative, quite general CMT variant, very close to common ways of reasoning in integrated optics,
- alternatively: a numerical (FEM) approach with highly specialized basis functions,
- 3-D HCMT demonstrated: numerical basis fields, still moderate effort,
- pending:

